

# Belcher Bits BB24: RAF Type H trolley 1/48

## Background

In 1941, Dr. Barnes Wallis of Vickers proposed the use penetrating weapons to undermine foundations. Under the codename Tallboy, aerodynamic prototypes of 4,000 lb capacity (small) as well as operational 12,000 lb (medium) and 22,000 lb (large) bombs were constructed. Because of their massive steel cases, the charge-weight ratio of these bombs put them in medium capacity (MC) range. The Tallboy(M) became the 12,000 lb MC, and was referred to as simply Tallboy, the larger Tallboy(L) became the 22,000 lb MC commonly called Grand Slam.

Tallboys were 38" in diameter, the same as the 8,000 and 12,000 lb HC blockbusters and could be carried internally in Lancasters with enlarged bomb bays. The Grand Slam was 46" in diameter and was carried externally under specially modified Lancasters only operated by 617 Squadron.

For aerodynamic reasons, both bomb types had no external bomb shackles and were held in place with chain-type straps. The bombs had to be hoisted up into position using a specially modified Type H bomb trolley with hoist frames and four 4,000 lb winches. This set represents one of those trolleys.

## Before Assembly

As with all resin sets, wash all the parts in a strong detergent and rinse in clear water to remove any oils or mould releases. Remove pour stubs and clean up the parts; use a mask when sanding resin and wet sand where possible. Cyanoacrylate adhesives work best but quickly; use five minute epoxy if joint requires manipulation while setting. These instructions follow the step-by-step kit instructions.

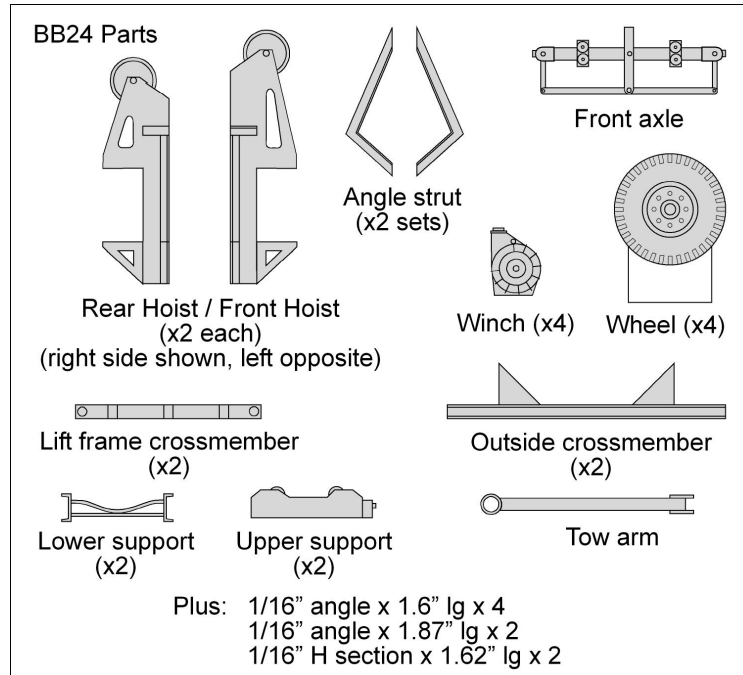

## Belcher Bits

33 Norway Spruce Street, Stittsville, ON, Canada K2S 1P3  
 Phone: (613) 836-6575, e-mail: info@belcherbits.com

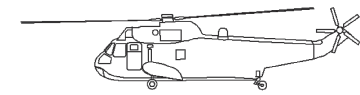

## Hoist frame

Clean up the main frame, removing flash on the bottom and around the base. Clean up the hoist frames. Lightly sand the inside of each frame to open up flashed-over hole, and remove the flash inside the angle strut moulded at right angles to the hoist frame.

Clean up the additional angle struts. One should be glued in place on each hoist frame, facing the one already cast in place with the flange on the outside. See Figure 1.

Glue the hoist frames in place. The base of each frame sits on the small rectangular tabs on the main main frame. The tall frame is in front, the shorter behind. This is a key step, so ensure the frames are vertical. Refer to Figure 2.

Clean up the outside crossmembers, and glue in place. These sit on the main frame, just in front of the front hoists and in rear of the rear hoist; they run from the outer edges of the angle struts and the triangular gussets glue to the hoist frames and help keep the hoists vertical. Cut the 1.9" supplied angles to exactly 1.87" (47.5 mm) long, and glue these inside crossmembers across the frame INSIDE the hoist frames.

Now the tricky part. The hoists are cross braced with angles on the outside. Use the supplied pieces 1.6" (40 mm) long, and carefully trial and trim the ends to fit where shown on Figure 2. Note the angle from the upper forward to lower rear is outside the hoist frame, while the other angle sits between the hoist frames; both of them have their horizontal flange on the bottom. When these are in place, put the trolley down and go have a drink ... the hardest work is done.

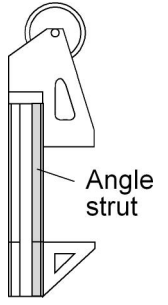

Figure 1

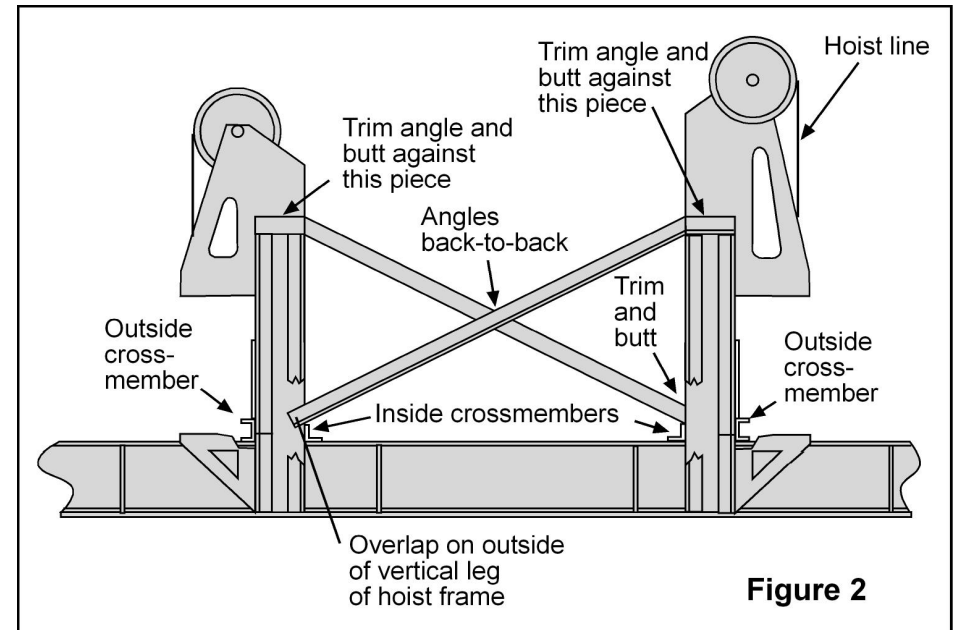

Figure 2

## Winches

The winches can be glued in place where shown. However, note that these winches could swivel, so if you want to make some sort of diorama with ground crew bending to their tasks, you may want to leave the attachment of these until you have your figures planned out and positioned. The crank handles are not supplied, but they can be easily made from plastic strip. I would recommend not fitting them until everything else is done and painted.

## Lift frame

Clean up the two crossmembers. Cut three pieces of the supplied H section to 1.62" (xx mm) long. These H sections sit in the slots in the cross members.

Clean up the upper and lower supports. Glue the upper to the lower as shown in Figure 3. Glue these on the lift frame, just inside the crossmembers. Note the upper supports have an adjustment screw on one side ... make sure the two supports both face the same way.

At this point you need to decide how high you want the lift frame positioned. If you are doing a Lancaster diorama, you may want to test fit the trolley, bomb and aircraft to see how it all goes together. Once you have a height decided (and it doesn't have to be completely level ... this trolley could lift the front higher than the rear), spread the hoist frames slightly and slip the lift frame into the recesses in the hoist frame insides. Move the lift frame to the desired height, and glue in place.

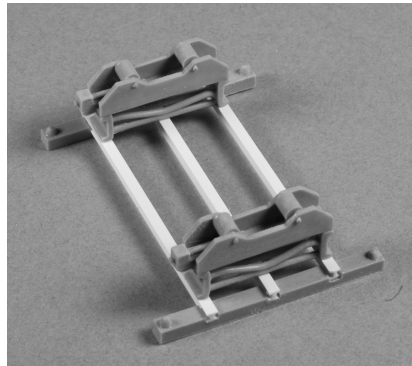

**Figure 3**

## Wheels and Axles

Glue the front axle in place; it sits on the two projecting arms at the front of the frame. The axle springs should be just flush with the front of those arms. Clean up the wheels and glue in place on the short stub axles on the frame (rear) and the front axle. Depending on your diorama preferences and the tow vehicle of choice (if any), position the tow arm on the tongue of the front axle and glue in place.

## Final steps

How much do you hate rigging? This trolley has a little bit, unfortunately. The winch lines go up through the hoist frame, out the angled section and over the pulley on top, back down through the hoist frame and to those round projections on top of the lift frame. I don't know the best way to represent this except to use some fine wire over the pulley; the section of line inside the leg of the hoist frame is hardly visible.

## Painting

At a guess, dark green overall. Good photos of wartime service are rare, but the example in the RAF Museum is painted green. Some photos show white winches.

## Options

The original Type H trolley (without any hoist frame) was used to transport very heavy bombs. Simply remove the four square tabs on the outside of the main frame and leave off all the hoist frame and lift frame material. Belcher Bits set BB-10 provides the 8,000 and 12,000 lb blockbuster bombs.

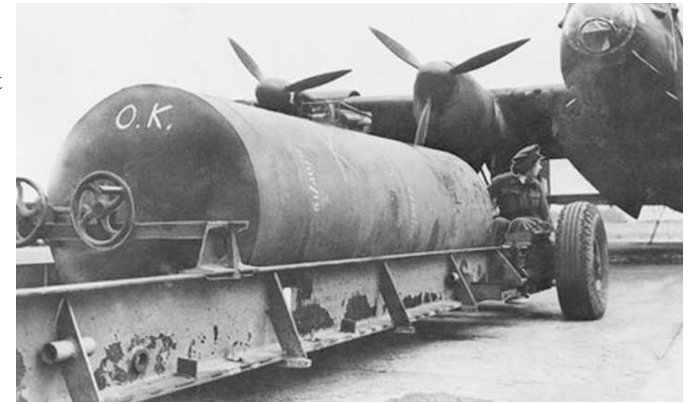

**An 8,000 lb HC bomb being backed into position; it could be accommodated within the Lancaster's bulged bomb bay**

## References

1. **Photos of example at RAF Museum Hendon. Special thanks to Maarten Bilo who made a specific trip there to take a few measured photos to supplement my more touristy shots. Thanks, Maarten; couldn't have made this without your help.**
2. **A Hell of a Bomb**, Stephen Flower, Tempus Publishers, 2002
3. **Bombs Gone**, John MacBean, 1990

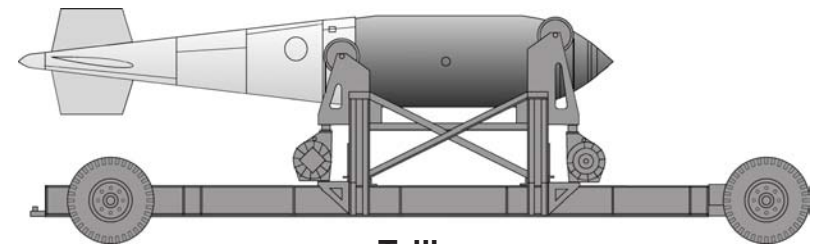

**Tallboy**

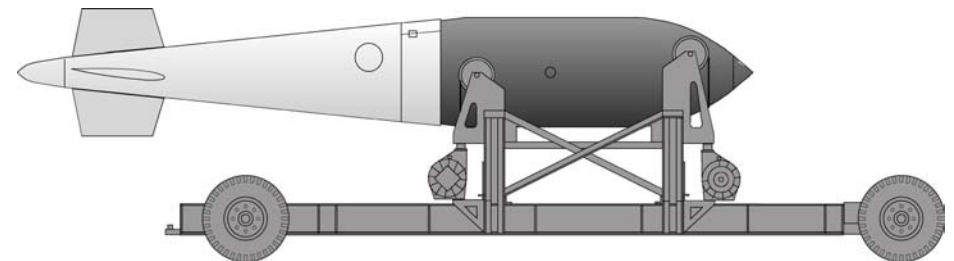

**Grand Slam**